

Datasheet

Tree Extension

Part No: 100218



About the product

The Loxone Tree Extension is used to extend the Miniserver, and allows the integration of various devices that are equipped with the Loxone Tree technology.

Technical Data

| | |
|-------------------------|---|
| Power supply | 9 ... 28VDC |
| Power consumption | typ. 0.30W |
| Interfaces | Loxone Tree: 2 branches, up to 50 devices per branch max. 500m wire length per branch Loxone Link: connection with Miniserver |
| Power loss at max. load | 0.12W |
| Ambient temperature | -40 ... 70°C / -40 ... 158°F |
| Humidity | max. 95% r.H. (non condensing) |

Connections

| | Loxone Tree | Power Supply, Loxone Link |
|---------------------------|--|---|
| Wire cross-section | 0.25 ... 0.8mm ² / AWG23 ... 18 | 0.05 ... 2.5mm ² / AWG30 ... 12 |
| Stripping length | 5mm / 0.2" | 6 ... 7.5mm / 0.24 ... 0.30" |
| Torque of terminal blocks | - | 0.5 ... 0.6Nm / 0.37 ... 0.44 lbf ft |
| Temperature resistance | -40 ... 105°C / -40 ... 221°F | min. 80°C / 176°F for IEC, min. 75°C / 167°F for UL, |
| Orange / White | - | +24VDC / GND |
| Blue / White | - | Loxone Link |
| Green / White | Loxone Tree | - |

Connection Diagram

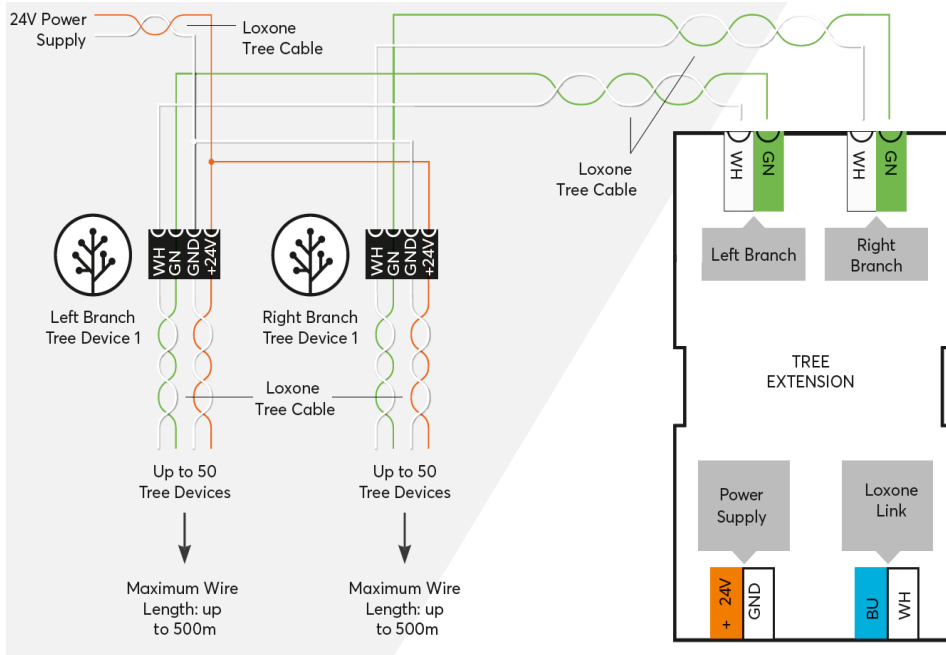

Product Characteristics

| | |
|---------------|-------------------------------------|
| Mounting type | DIN rail according to EN50022, 35mm |
| Colours | Black: RAL 9005 |
| Finish | Matte |

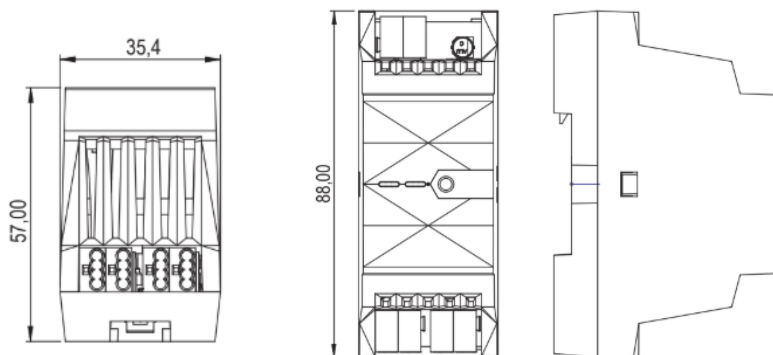

Weight & Dimensions

| | |
|--------------------|--|
| Net weight | 60g |
| Total weight | 85g |
| Product dimensions | 88x35.4x57mm / 3.46x1.39x2.24" (LxWxH) |



| | |
|-----------|---|
| Pack size | 113x69x70.5mm / 4.45x2.72x2.78" (LxWxH) |
|-----------|---|

Certifications & Standards

| | |
|----------------|---|
| Safety rating | IP20 |
| | UL 62368-1 CSA C22.2#62368-1 |
| Certifications |    |

Installation must be carried out by a qualified electrician in accordance with the relevant regulations.

Published by
Loxone Electronics GmbH
Smart Home 1
4154 Kollerschlag
Austria
Tel: +43 7287 7070-0
loxone.com

Loxone UK
The Forum
Station Road
Theale, RG7 4RA
United Kingdom

Datenblatt

Tree Extension

Art. Nr. 100218

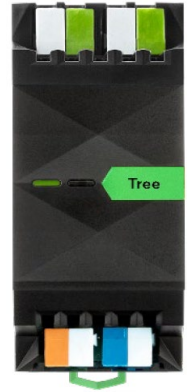

Information zum Produkt

Die Loxone Tree Extension dient zur Erweiterung des Miniservers, und ermöglicht das Einbinden zahlreicher Geräte, die mit der Loxone Tree Technologie ausgestattet sind.

Technische Daten

| | |
|-------------------------------|--|
| Spannungsversorgung | 9 ... 28VDC |
| Leistungsaufnahme | typ. 0.30W |
| Schnittstellen | Loxone Tree: 2 Äste, bis zu 50 Geräten je Ast max. 500m Kabellänge je Ast Loxone Link: Verbindung mit Miniserver |
| Verlustleistung bei max. Last | 0.12W |
| Umgebungstemperatur | -40 ... 70°C / -40 ... 158°F |
| Luftfeuchtigkeit | max. 95% r.H. (nicht kondensierend) |

Anschlüsse

| | Loxone Tree | Spannungsversorgung, Loxone Link |
|-------------------------|--|--|
| Leiterquerschnitt | 0.25 ... 0,8mm ² / AWG23 ... 18 | 0,05 ... 2,5mm ² / AWG30 ... 12 |
| Abisolierlänge | 5mm / 0,2" | 6 ... 7,5mm / 0,24 ... 0,30" |
| Drehmoment der Klemmen | - | 0,5 ... 0,6Nm / 0,37 ... 0,44 lbf ft |
| Temperaturbeständigkeit | -40 ... 105°C / -40 ... 221°F | min. 80°C / 176°F für IEC, min. 75°C / 167°F für UL |
| Orange / Weiß | - | +24VDC / GND |
| Blau / Weiß | - | Loxone Link |
| Grün / Weiß | Loxone Tree | - |

Anschlussplan

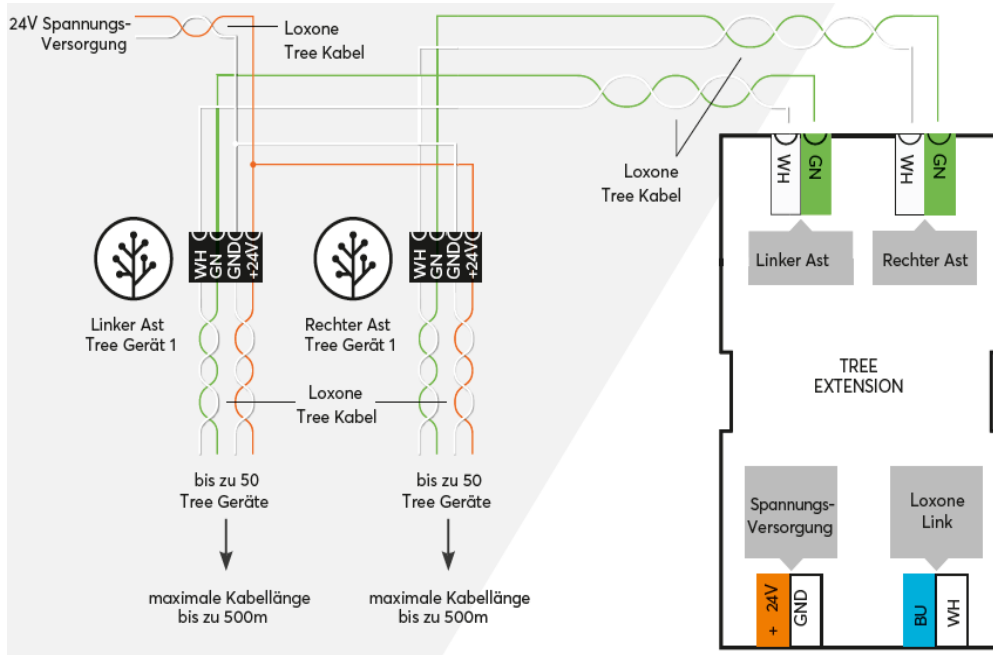

Produkteigenschaften

| | |
|------------|-------------------------------|
| Montageart | Hutschiene nach EN50022, 35mm |
| Farbe | Schwarz: RAL 9005 |
| Glanzgrad | Matt |

Gewicht & Abmessungen

| | |
|---------------|--|
| Nettogewicht | 60g |
| Bruttogewicht | 85g |
| Produktmaße | 88x35,4x57mm / 3,46x1,39x2,24" (LxBxH) |

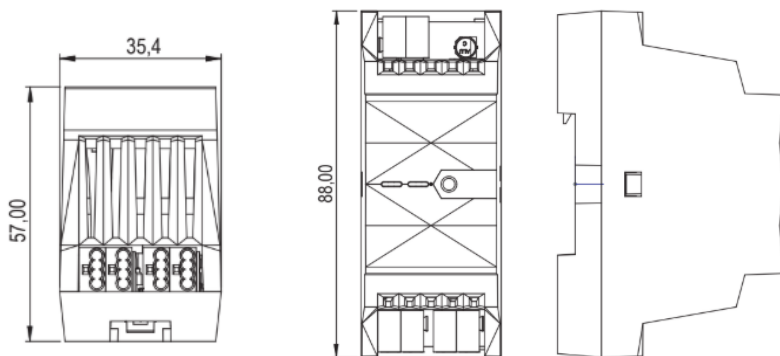

| | |
|---------|---|
| Packmaß | 113x69x70,5mm / 4,45x2,72x2,78" (LxBxH) |
|---------|---|

Zertifizierungen & Standards

| | |
|------------------|--|
| Schutzart | IP20 |
| Zertifizierungen | UL 62368-1 CSA C22.2#62368-1    |

Die Installation muss nach den einschlägigen Vorschriften durch eine Elektrofachkraft erfolgen.

Veröffentlicht von
Loxone Electronics GmbH
Smart Home 1
4154 Kollerschlag
Austria
Tel: +43 7287 7070-0
loxone.com

Loxone UK
The Forum
Station Road
Theale, RG7 4RA
United Kingdom